

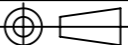



Schaal: 1:2	Naam: H. Bos	
Maateenheid: mm	Klas:	
Amerikaanse projectie 	Datum: 24-1-2022	
 Bossienbus.nl	Omschrijving Balkje-samenstelling	
	Bestand: Bevestiging-stuurhuis	A3



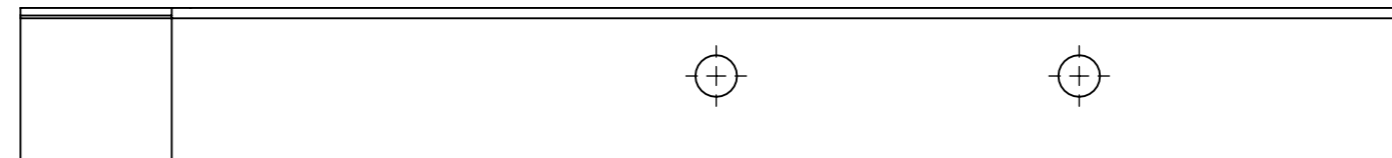
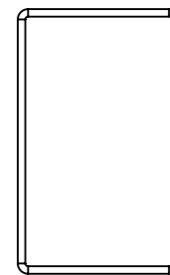
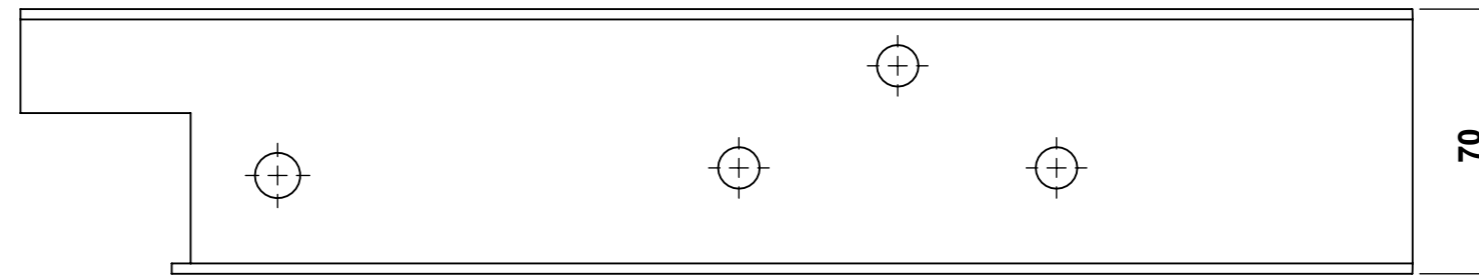
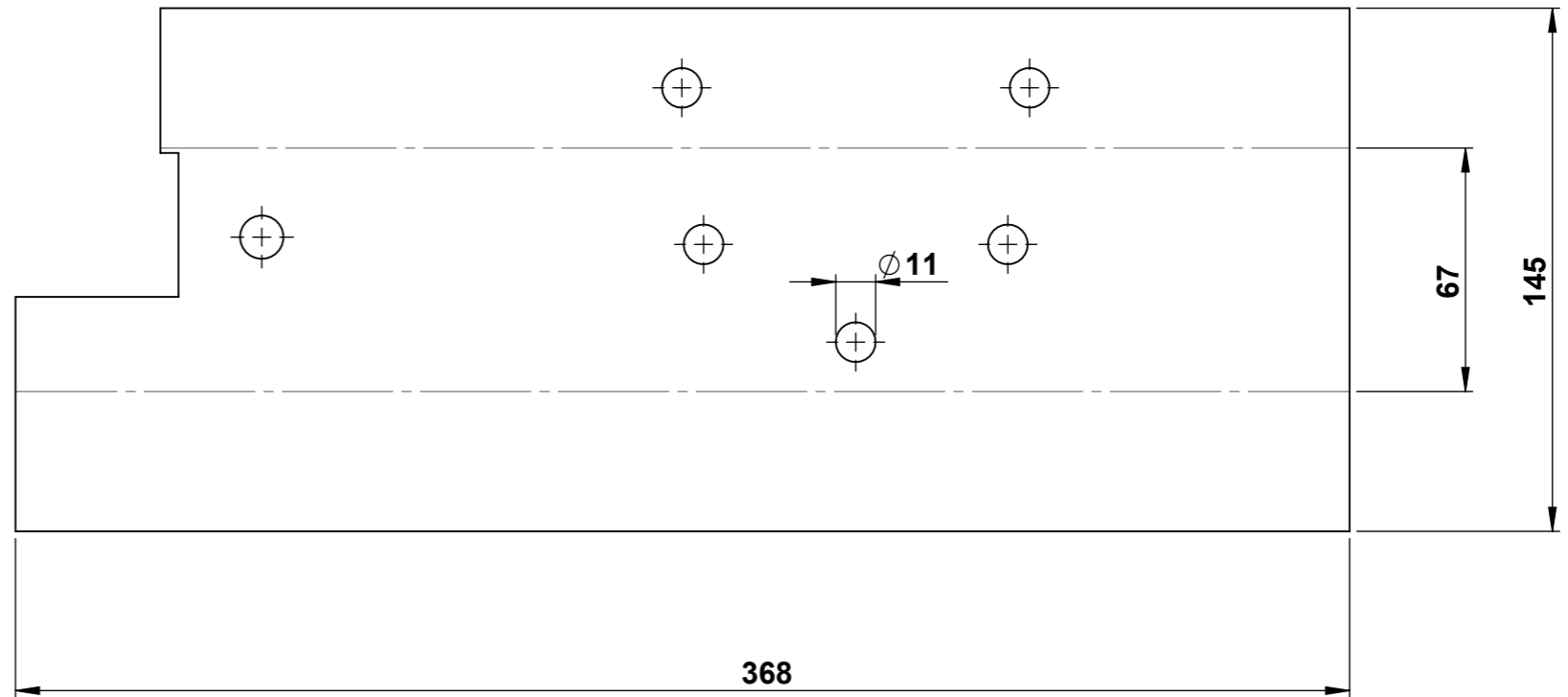
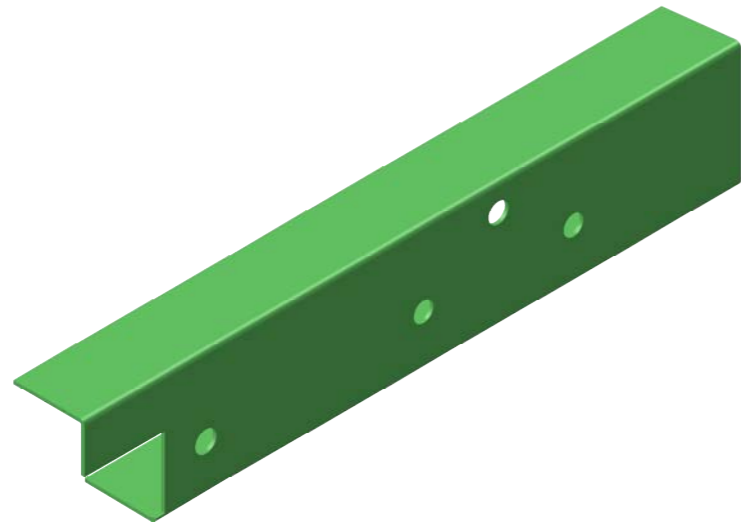
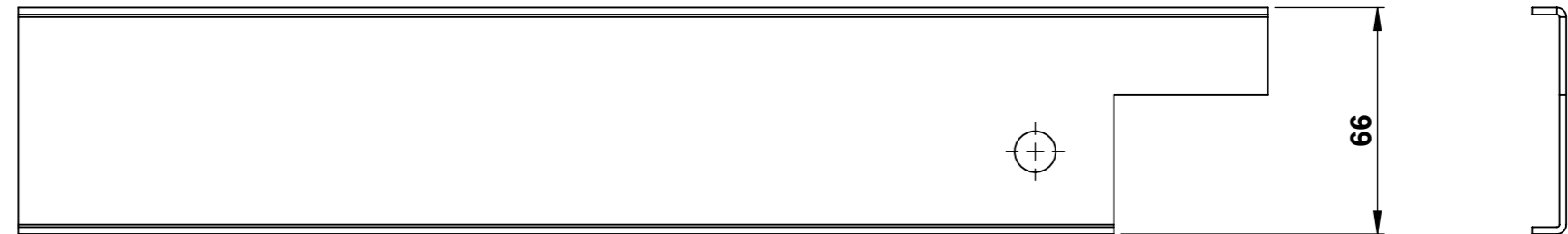
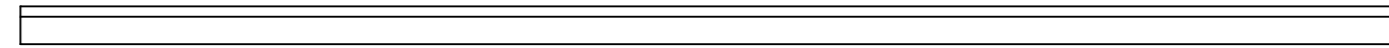
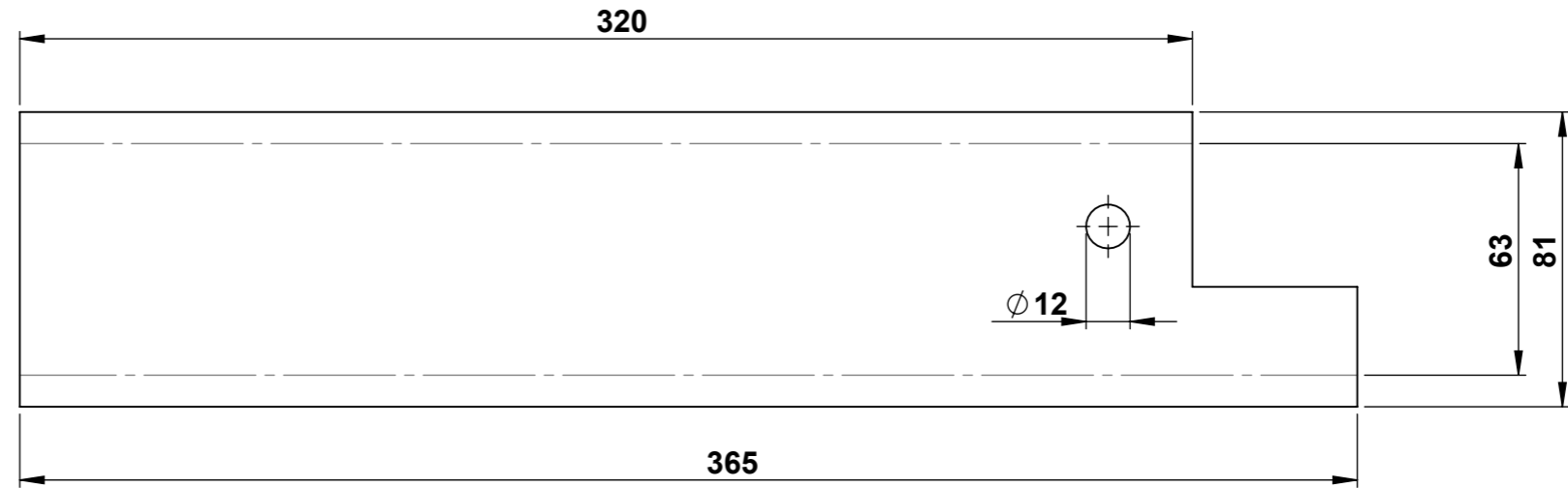
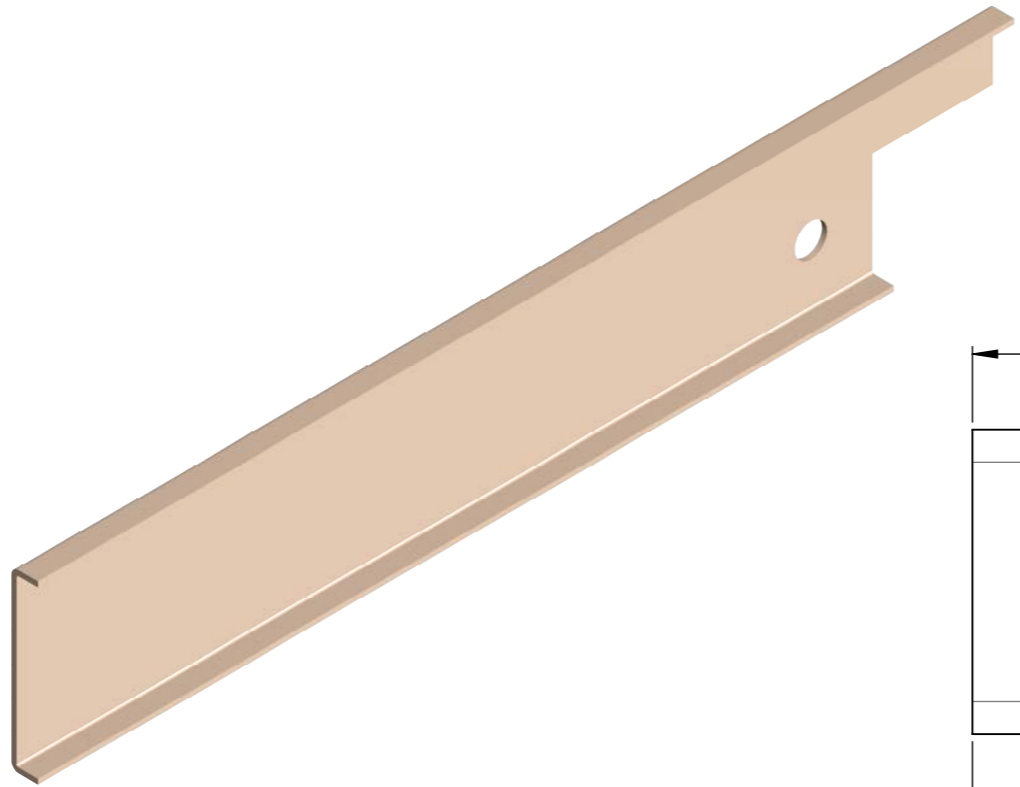
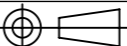

Schaal: 1:2	Naam:	
Maateenheid: mm	Klas:	
Amerikaanse projectie	Datum: 24-1-2022	
Bossienbus.nl	Omschrijving Balkje-buitendeel	
	Bestand: Bevestiging-stuurhuis	A3



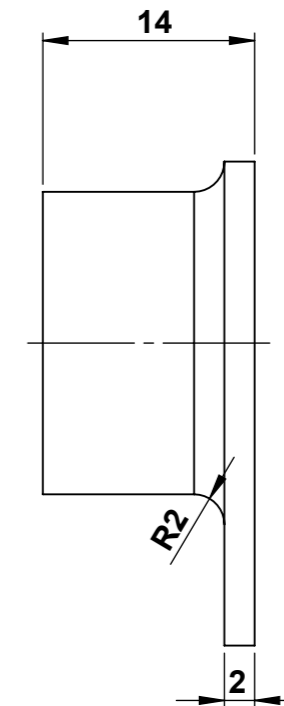
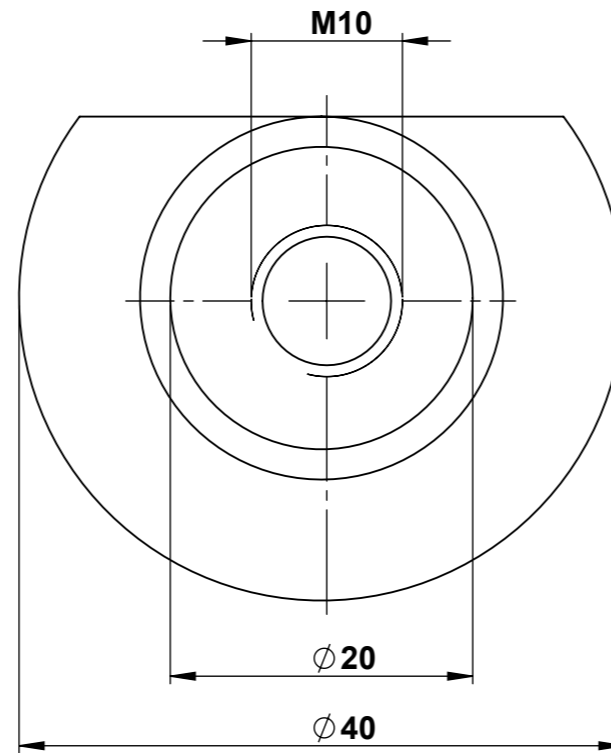
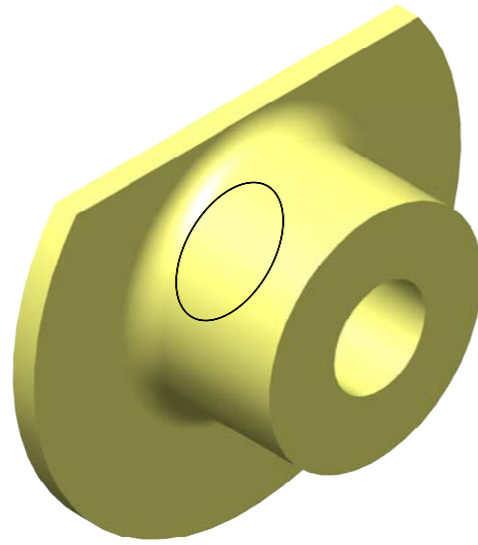

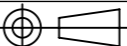
Schaal: 1:2	Naam: H. Bos	
Maateenheid: mm	Klas:	
Amerikaanse projectie 	Datum: 24-1-2022	
 Bossienbus.nl	Omschrijving Balkje-binnendeel	
	Bestand: Bevestiging-stuurhuis	A3

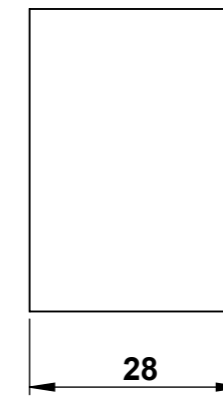
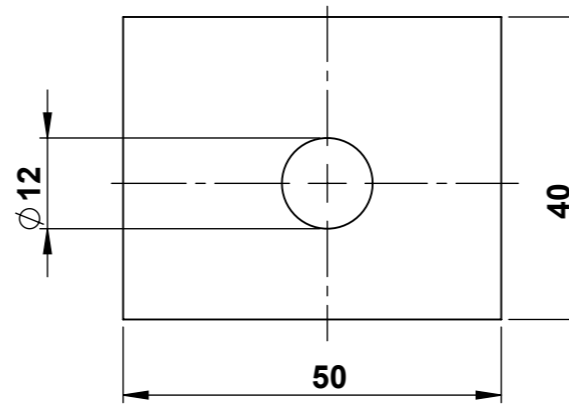
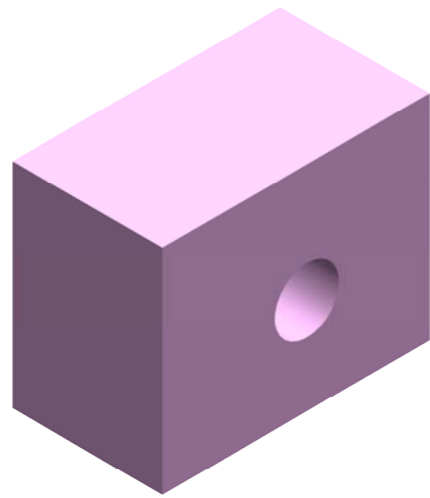

Schaal: 2:1	Naam:	
Maateenheid: mm	Klas:	
Amerikaanse projectie 	Datum: 24-1-2022	
 Bossienbus.nl	Omschrijving	
	Bestand: Bevestiging-stuurhuis	A3

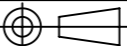

Schaal: 2:1	Naam:	
Maateenheid: mm	Klas:	
Amerikaanse projectie 	Datum: 24-1-2022	
 Bossienbus.nl	Omschrijving Opvulblokje	
	Bestand: Bevestiging-stuurhuis	A3